

A1	GND	B12	GND
A4	VBUS	B9	VBUS
A5	CC1	B7	Dn2
A6	D+	B6	Dp2
A7	D-	B5	CC2
A9	VBUS	B4	VBUS
A12	GND	B1	GND
PIN	SIGNAL NAME	PIN	SIGNAL NAME

REV	DESCRIPTION	DATE	APPROVED
A	新版发行	2024.04.22	HHM

SPECIFICATION:

- ELECTRICAL:
  - CURRENT RATING:5A;
  - CONTACT RESISTANCE:40mΩ Max;
  - DIELECTRIC WITHSTANDING VOLTAGE:100V AC;
  - INSULATION RESISTANCE:100 MΩ MIN;
- MECHANICAL;
  - MATING FORCE:5~20N;
  - UNMATING FORCE:8~20N;
  - DURABILITY:10000 CYCLES;6~20N AFTER DURABILITY TEST;
- MATERIAL:
  - HOUSING&MOLDING:LCP BLACK UL94V-0;
  - TERMINAL:C7025 T=0.15mm;
  - SHELL:SUS304 T=0.30mm;
  - MID PLATE:SUS304 T=0.20mm;
- PLATING SPECIFICATION:
  - NI 40u" Min. UNDER PLATED OVER ALL.
  - TERMINAL:CONTACT POINT GOLD PLATED 3u" Min PIN WELDING AREA GOLD PLATED 1u" Min.
  - SHELL:PLATED Ni 50u" Min(Salt spray 48H)
- ELECTROPLATED PRODUCTS NEED TO UNDERGO TIN ADHESION TESTING: THE TIN ADHESION AREA SHOULD REACH OVER 95%.
- SMT REFLOW SOLDERING (PEAK VALUE 260 ° C ± 5 ° C) SHALL BE FREE OF BLISTERING, GLUE MELTING AND POOR COLOR CHANGE (DEFORMATION WITHIN TOLERANCE)
- OPERATING TEMPERATURE: -40° C~+85° C

CUSTOMER DRAWING		
UNITS mm	SCALE 1:1	SHEET 1 OF 2
PROJECTION: 	DRAW: DAP	
GENERAL TOLERANCE	CHECK: HWT	
.000 ±0.15	APPD: HHM	
.00 ±0.20		
.0 ±0.25		
.0 ±2°		
.00 ±1°		

铭创科技（东莞）有限公司 Mingchuang Technology (Dongguan) Co., Ltd.			
TITLE TYPE C母座14PIN 立式四脚插版SMT L=10.0 A款			
MAT'L	SEE TABLE	FINISH	SEE TABLE
DWG. NO.	A031416A	PART NO.	SIZE A4



REV	DESCRIPTION	DATE	APPROVED
A	新版发行	2024.04.22	HHM

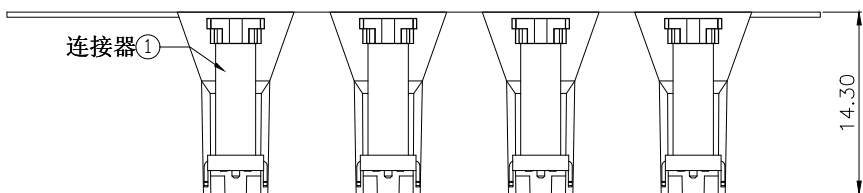
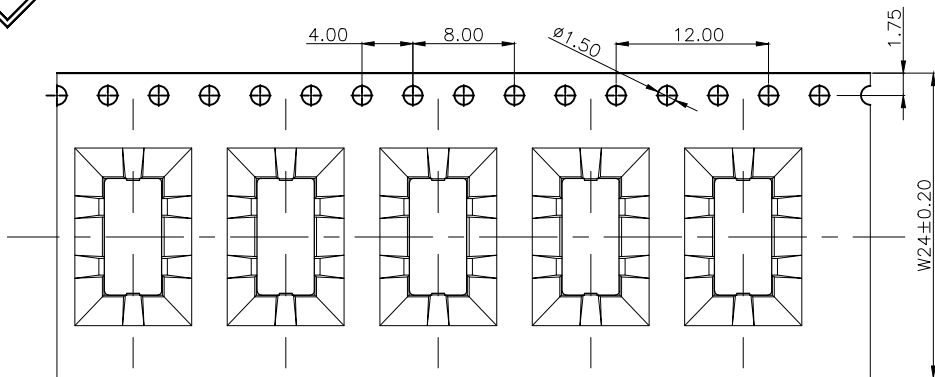

产品入载带示意图

剥离角度: 165°~180°  
剥离力: 40gf~120gf  
用户取件方向

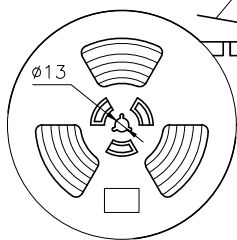
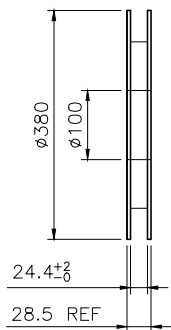

卷盘示意图

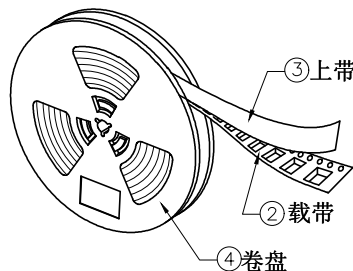

包装示意图

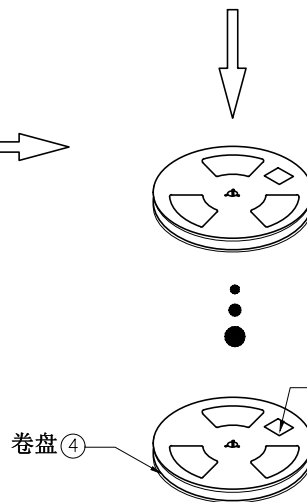

卷盘贴标签示意图

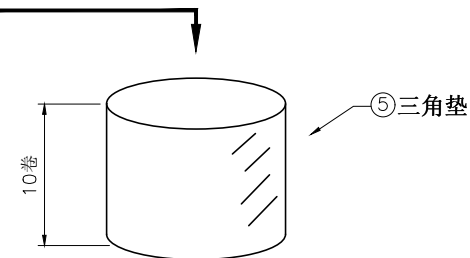

10盘产品叠层示意图

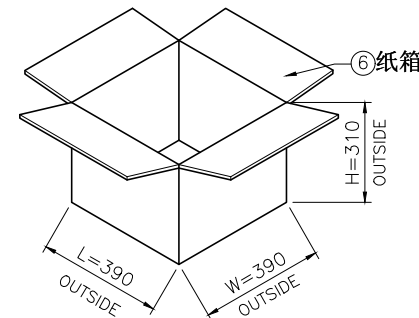

序号	物料名称	物料编号	规格	描述
06	纸箱	B-05-0012	390mm*390mm*310mm	1 PCS
05	三角垫	/	300mm*260mm*7mm	4 PCS
04	卷盘	/	D=380mm, d=100mm, H=28.5mm	10 PCS
03	上带	/	W=20.7mm, T=0.05mm	6240 mm
02	载带	B-03-0037	W=24mm, T=0.50mm, P=12.0mm	6240 mm
01	连接器	A031416A	14PIN, SMT	5000 PCS

CUSTOMER DRAWING			铭创科技(东莞)有限公司		
UNITS mm	SCALE 1:1	SHEET 2 OF 2	Mingchuang Technology (Dongguan) Co., Ltd.		
PROJECTION: 	DRAW: DAP	TITLE TYPE C母座14PIN 立式四脚插版SMT L=10.0 A款			
GENERAL TOLERANCE .000 ±0.15 .00 ±0.20 .0 ±0.25 .0 ±2° .00 ±1°	CHECK: HWT	MAT'L SEE TABLE	FINISH SEE TABLE		D
	APPD: HHM	DWG. NO. A031416A	PART NO.	SIZE A4	