

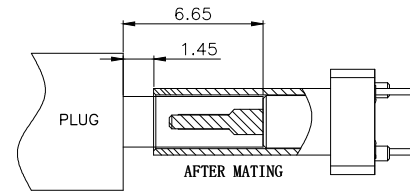

REV	DESCRIPTION	DATE	APPROVED
A	新版发行	2023.07.18	HHM

SPECIFICATION:

- ELECTRICAL:
 - CURRENT RATING:5A;
 - CONTACT RESISTANCE:40mΩ Max;
 - DIELECTRIC WITHSTANDING VOLTAGE:100V AC;
 - INSULATION RESISTANCE:100 MΩ MIN;
- MECHANICAL;
 - MATING FORCE:5~20N;
 - UNMATING FORCE:8~20N;
 - DURABILITY:10000 CYCLES;6~20N AFTER DURABILITY TEST;
- MATERIAL:
 - HOUSING&MOLDING:BLACK LCP UL94V-0;
 - TERMINAL:C7025 T=0.15mm;
 - SHELL:SUS304 T=0.30mm;
 - MID PLATE:SUS304 T=0.15mm;
- PLATING SPECIFICATION:
 - TERMINAL:CONTACT POINT GOLD PLATED 3u"MIN
PIN WELDING AREA GOLD PLATED 1u" MIN.
 - SHELL:PLATED Ni 60u" MIN(Salt spray 48H)
- ELECTROPLATED PRODUCTS NEED TO UNDERGO TIN ADHESION TESTING: THE TIN ADHESION AREA SHOULD REACH OVER 95%.
- SMT REFLOW SOLDERING (PEAK VALUE 260 ° C ± 5 ° C) SHALL BE FREE OF BLISTERING, GLUE MELTING AND POOR COLOR CHANGE (DEFORMATION WITHIN TOLERANCE)
- OPERATING TEMPERATURE: -40° C~+85° C

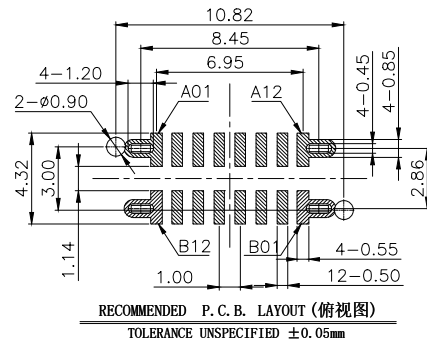
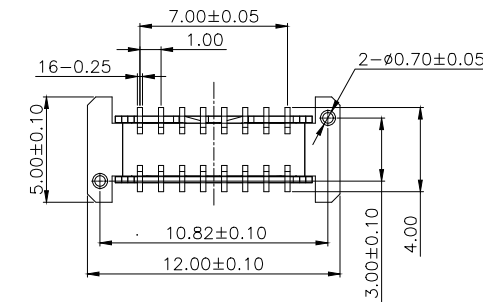
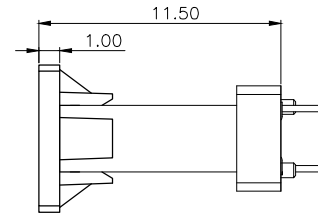
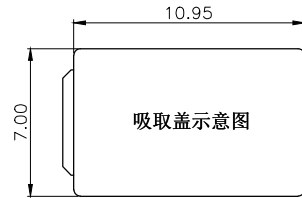
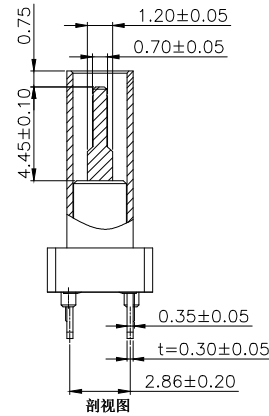
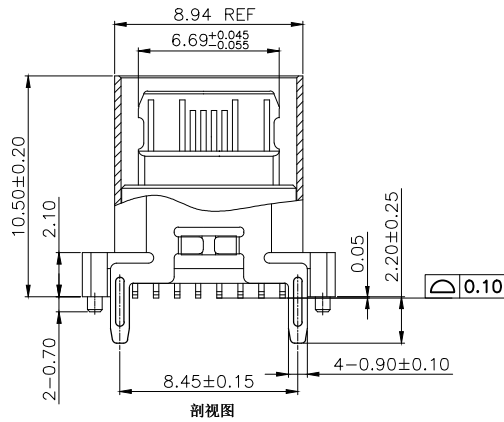
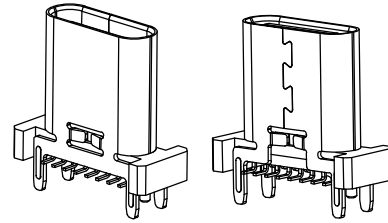
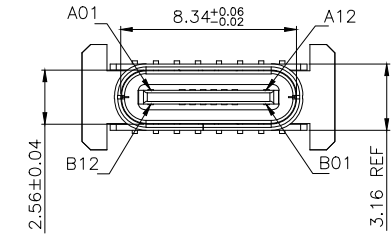

A1	GND	B12	GND
A4	VBUS	B9	VBUS
A5	CC1	B8	SBU2
A6	D+	B7	D-
A7	D-	B6	D+
A8	SBU1	B5	CC2
A9	VBUS	B4	VBUS
A12	GND	B1	GND
PIN	SIGNAL NAME	PIN	SIGNAL NAME

CUSTOMER DRAWING		
UNITS mm	SCALE 1:1	SHEET 1 OF 2
PROJECTION: 	DRAW: DAP	
GENERAL TOLERANCE .000 ±0.15 .00 ±0.20 .0 ±0.25 .0 ±2° .00 ±1°	CHECK: HWT	MAT'L SEE TABLE
	APPD: HHM	FINISH SEE TABLE
		DWG. NO. A031608A
		SIZE A4

铭创科技（东莞）有限公司
Mingchuang Technology (Dongguan) Co., Ltd.

TITLE
TYPE C母座16PIN 立式四脚插板SMT L=10.5 A款

