

3D VIEW

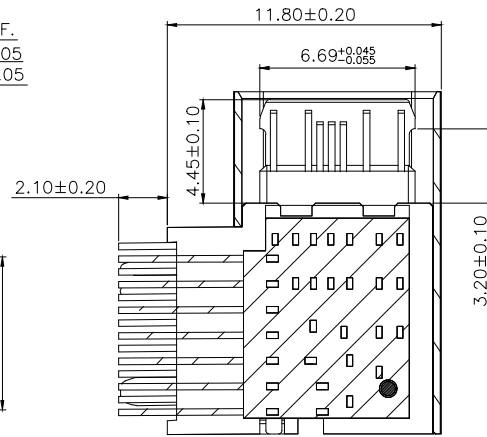

剖视图

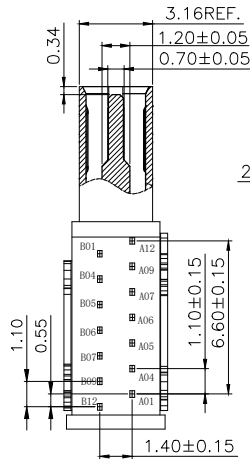
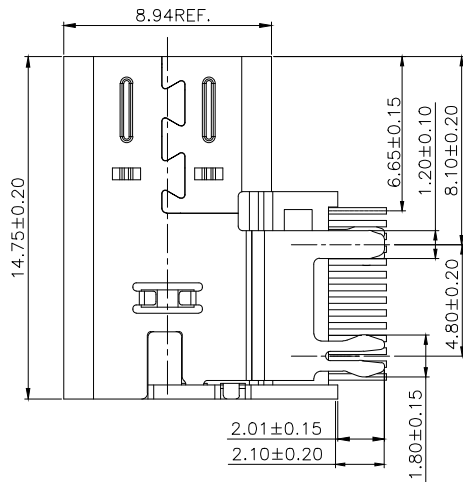
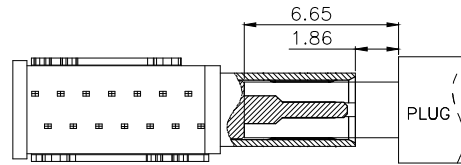
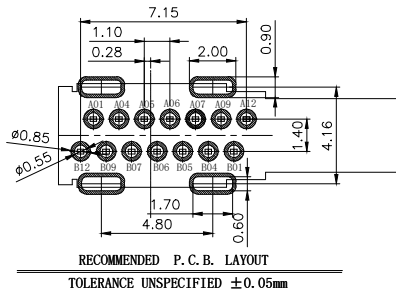
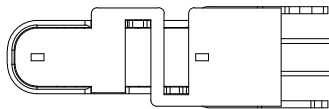

AFTER MATING

A1	GND	B12	GND
A4	VBUS	B9	VBUS
A5	CC1		
A6	D+	B7	Dn2
A7	D-	B6	Dp2
		B5	CC2
A9	VBUS	B4	VBUS
A12	GND	B1	GND
PIN	SIGNAL NAME	PIN	SIGNAL NAME

REV	DESCRIPTION	DATE	APPROVED
A	新版发行	2024.07.18	HHM

SPECIFICATION:

- ELECTRICAL:
  - CURRENT RATING:5.0A;
  - CONTACT RESISTANCE:40mΩ Max;
  - DIELECTRIC WITHSTANDING VOLTAGE:100V AC;
  - INSULATION RESISTANCE:100 MΩ MIN;
- MECHANICAL:
  - MATING FORCE:5~20N;
  - UNMATING FORCE:8~20N;
  - DURABILITY:10000 CYCLES;6~20N AFTER DURABILITY TEST;
- MATERIAL:
  - HOUSING&MOLDING: BLACK LCP UL94V-0;
  - TERMINAL:C2680 T=0.20mm;
  - SHELL:SUS304 T=0.30mm;
  - MID PLATE:SUS304 T=0.30mm;
- PLATING SPECIFICATION:
  - TERMINAL:CONTACT POINT GOLD PLATED 3u"Min  
PIN WELDING AREA TIN PLATED 80u" Min.
  - NI 40u" Min. UNDER PLATED OVER ALL.
  - SHELL:PLATED Ni 50u" Min(Salt spray 48H)
- ELECTROPLATED PRODUCTS NEED TO UNDERGO TIN ADHESION TESTING: THE TIN ADHESION AREA SHOULD REACH OVER 95%.
- SMT REFLOW SOLDERING (PEAK VALUE 260 ° C ± 5 ° C) SHALL BE FREE OF BLISTERING, GLUE MELTING AND POOR COLOR CHANGE (DEFORMATION WITHIN TOLERANCE)
- OPERATING TEMPERATURE: -40 ° C~+85 ° C

CUSTOMER DRAWING		
UNITS mm	SCALE 1:1	SHEET 1 OF 2
PROJECTION: 	DRAW: DAP	
GENERAL TOLERANCE .000 ±0.15 .00 ±0.20 .0 ±0.25 .0 ±2° .00 ±1°	CHECK: HWT	MAT'L SEE TABLE
	APPD: HHM	FINISH SEE TABLE
		DWG. NO. A031409B
		SIZE A4

铭创科技（东莞）有限公司 Mingchuang Technology (Dongguan) Co., Ltd.	
TITLE TYPE C母座14PIN 侧插四脚交叉小脚鱼叉脚DIP L=14.75 垫高2.7 CH=7.3	
MAT'L SEE TABLE	FINISH SEE TABLE
DWG. NO. A031409B	PART NO. _____
	SIZE A4



REV	DESCRIPTION	DATE	APPROVED
A	新版发行	2024.07.18	HHM

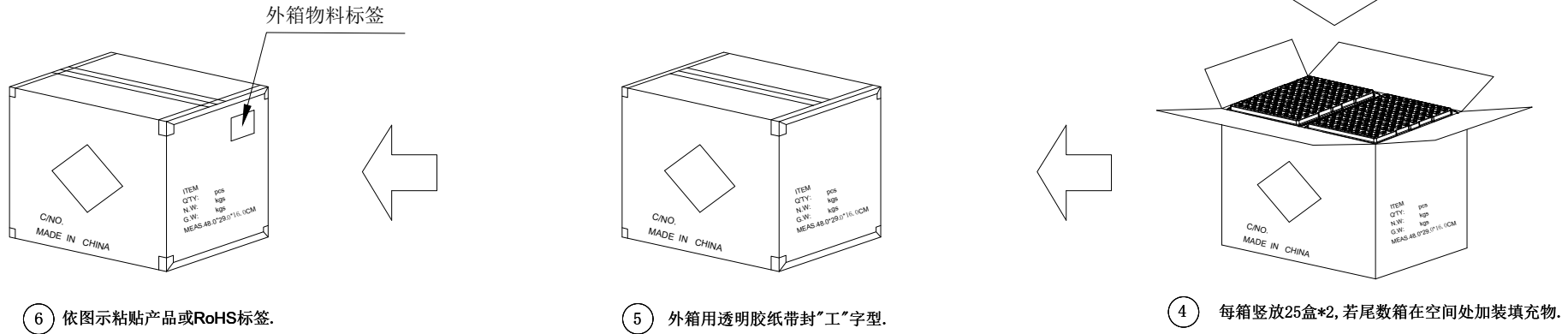
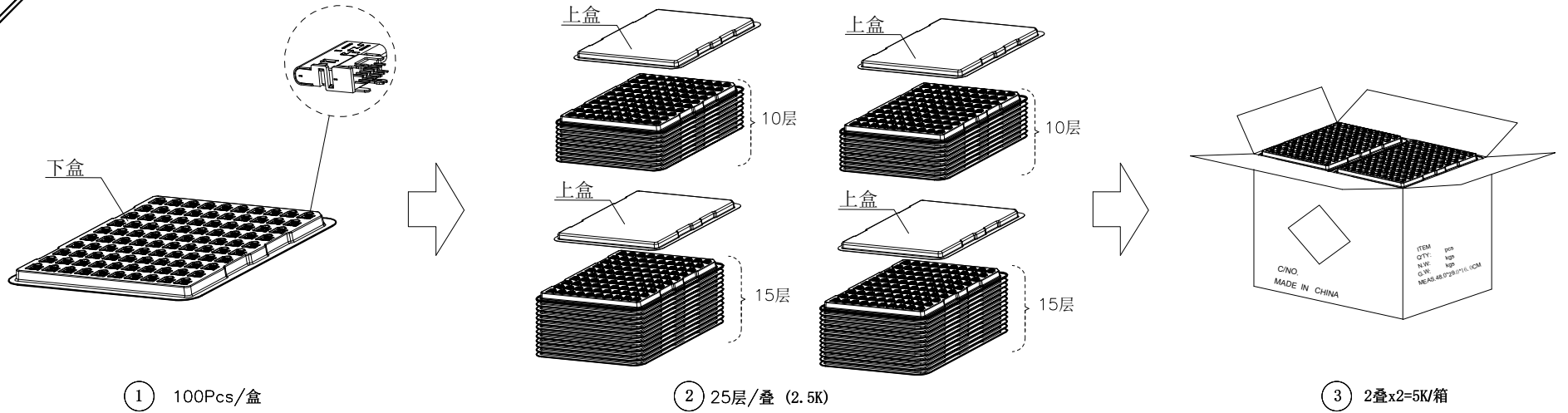

- 备注:
1. 每盒装成品100Pcs;
  2. 2叠15层+2叠10层, 每叠顶面加一个上盖;
  3. 每箱装50盒(5K);
  4. 外箱尺寸与规格: 48.0\*29.0\*16.0CM
  5. 外箱用透明胶纸带封"工"字型;

04	纸箱	B-05-0017	480mm*290mm*160mm	1 PCS
03	上盖	B-01-0018	PET透明 TO. 50*L280*W230*H11mm	4 PCS
02	下盒	B-01-0017	PET透明 TO. 45*L280*W230*H11mm	50 PCS
01	连接器	A031409B	14PIN, DIP	5000 PCS
序号	物料名称	物料编号	规格	描述

CUSTOMER DRAWING			铭创科技(东莞)有限公司 Mingchuang Technology (Dongguan) Co., Ltd.		
UNITS mm	SCALE 1:1	SHEET 2 OF 2	TITLE TYPE C母座14PIN 侧插四脚交叉小脚鱼叉脚DIP L=14.75 垫高2.7 CH=7.3		
PROJECTION: 		DRAW: DAP	MAT'L SEE TABLE		
GENERAL TOLERANCE .000 ±0.15 .00 ±0.20 .0 ±0.25 .0 ±2° .00 ±1°		CHECK: HWT	FINISH SEE TABLE		
		APPD: HHM	DWG. NO. A031409B	PART NO. _____	SIZE A4